

PEI HWA PRESBYTERIAN PRIMARY SCHOOL
PRELIMINARY EXAMINATION

PRIMARY 6
MATHEMATICS PAPER 1
(BOOKLET A)

19 August 2021

Name: _____

Form Class / Register No. : 6R_____ / _____

Total time for Booklets A and B: 1h

INSTRUCTIONS TO CANDIDATES

1. Write your Name, Class and Register No. in the spaces provided above.
2. DO NOT turn over this page until you are told to do so.
3. Follow all instructions carefully.
4. Answer all questions.
5. Shade your answers on the Optical Answer Sheet (OAS) provided.
6. The use of calculator is **NOT ALLOWED**.

This booklet consists of 8 printed pages, excluding the cover page.

Paper 1 (Booklet A)

Questions 1 to 10 carry 1 mark each. Questions 11 to 15 carry 2 marks each. For each question, four options are given. One of them is the correct answer. Make your choice (1, 2, 3 or 4). Shade the oval (1, 2, 3 or 4) on the Optical Answer Sheet.
(20 marks)

1. Round 355 074 to the nearest thousand.

- (1) 300 000
- (2) 350 000
- (3) 355 000
- (4) 360 000

2. Which of the following fractions is **not** equivalent to $\frac{1}{3}$?

- (1) $\frac{2}{6}$
- (2) $\frac{3}{9}$
- (3) $\frac{4}{10}$
- (4) $\frac{5}{15}$

3. In 5.789, what does the digit 7 stand for?

- (1) 7 ones
- (2) 7 tenths
- (3) 7 hundredths
- (4) 7 thousandths

4. Which of the following shows 80% of its figure shaded?

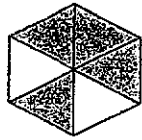

(1)



(2)

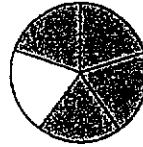

(3)

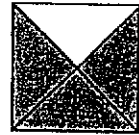

(4)

5. There were 12 red, yellow and green beads. 4 beads were red, 3 were yellow and the rest were green. Find the ratio of the number of red to yellow to green beads.

- (1) 3 : 5 : 4
(2) 4 : 3 : 5
(3) 4 : 5 : 3
(4) 5 : 3 : 4

6. Mrs Lim uses the pail as shown for mopping the house daily. Which of the following could be the capacity of the pail?

- (1) 8 l
(2) 8 ml
(3) 80 l
(4) 80 ml



7. Arrange the following from the heaviest to the lightest.

10.15 kg	10 kg 15 g	$10\frac{1}{5}$ kg
----------	------------	--------------------

- | | <u>Heaviest</u> | | <u>Lightest</u> |
|-----|--------------------|---|--------------------|
| (1) | $10\frac{1}{5}$ kg | , | 10.15 kg |
| (2) | $10\frac{1}{5}$ kg | , | 10 kg 15 g |
| (3) | 10.15 kg | , | 10 kg 15 g |
| (4) | 10 kg 15 g | , | $10\frac{1}{5}$ kg |

8. Which of the following figures has at least 2 lines of symmetry?



(1)



(2)

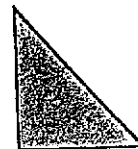

(3)



(4)

9. Which two lines in the square grid below are parallel to each other?

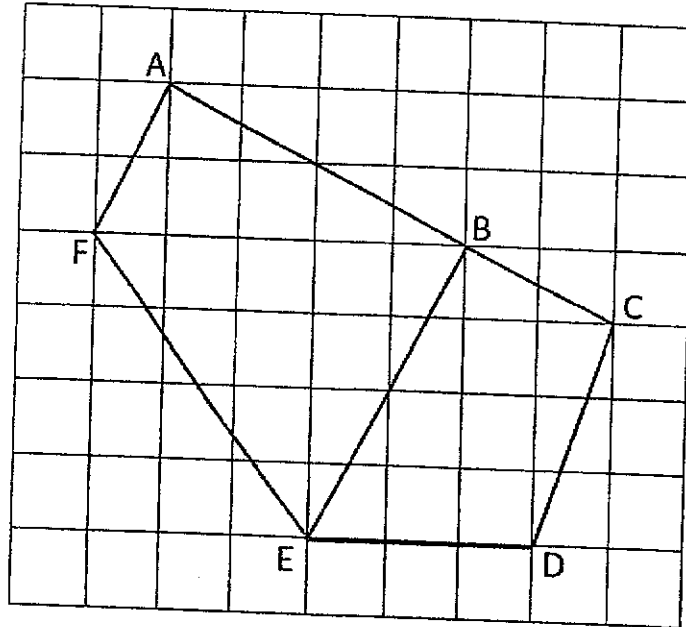

- (1) AB and BE
 (2) AF and CD
 (3) BE and CD
 (4) AF and BE
10. The table shows the favourite food of a group of pupils.
 Which type of food is the most popular among the boys?

Food	Number of Girls	Number of Boys	Total Pupils
Pizza	49	45	94
Burger	40	49	89
Fried Rice	50	44	94
Fried Noodle	47	48	95

- (1) Pizza
 (2) Burger
 (3) Fried Rice
 (4) Fried Noodle

11. The solid below is made up of 9 cubes.
Which of the following shows the two correct views of the solid?

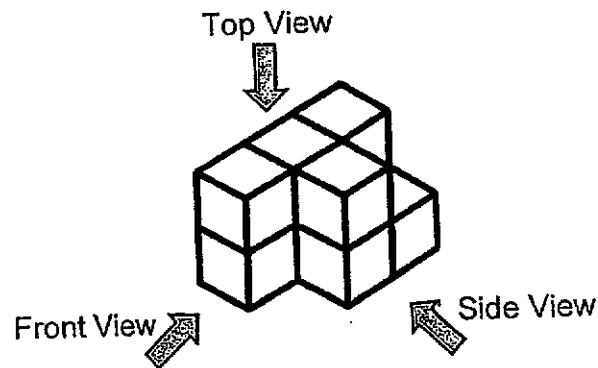

(1)

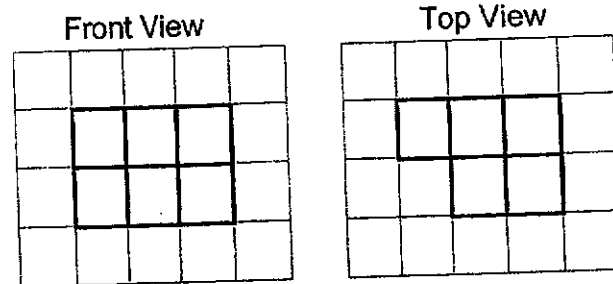

(2)

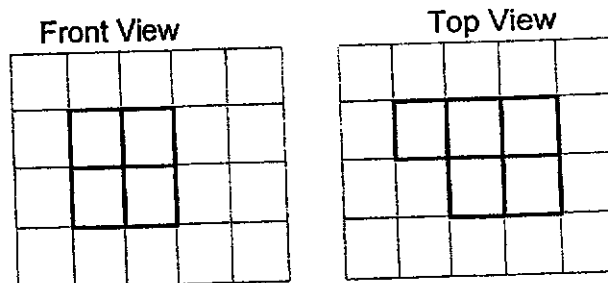

(3)

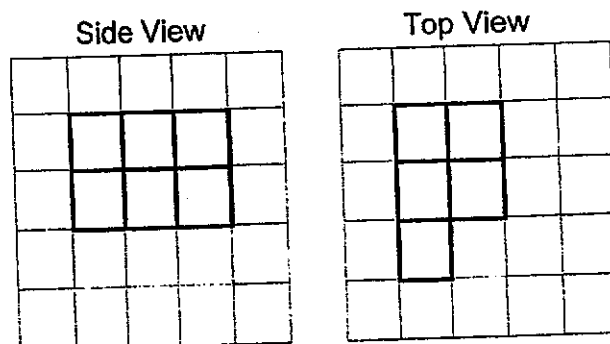

(4)

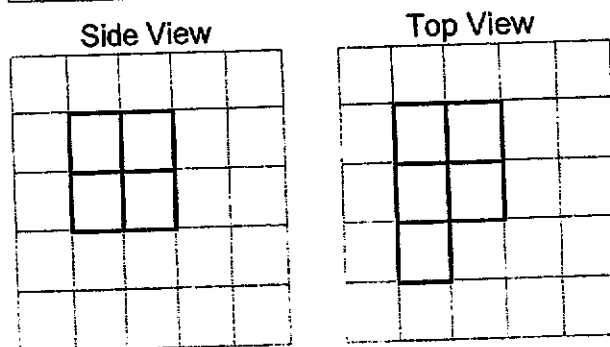

12. The figure below shows a circle with a square inside it. The diameter of the circle is 14 cm. Find the total area of the shaded parts.

- (1) $(49\pi - 49) \text{ cm}^2$
- (2) $(49\pi - 98) \text{ cm}^2$
- (3) $(196\pi - 98) \text{ cm}^2$
- (4) $(196\pi - 196) \text{ cm}^2$

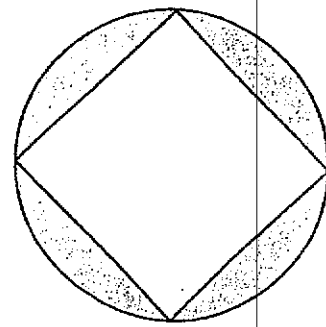

13. The figure below shows a square ABCD with E and F as mid-points. 3 smaller squares are shaded as shown. What fraction of the square ABCD is shaded?

- (1) $\frac{1}{3}$
- (2) $\frac{3}{7}$
- (3) $\frac{7}{24}$
- (4) $\frac{21}{64}$

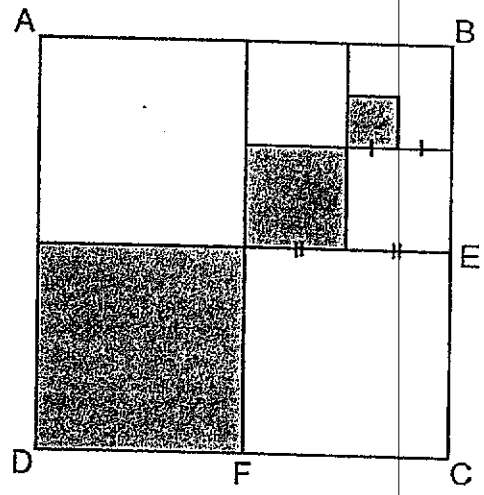

14. Two figures M and N are shown in the square grid below. $\angle v = \angle x$.

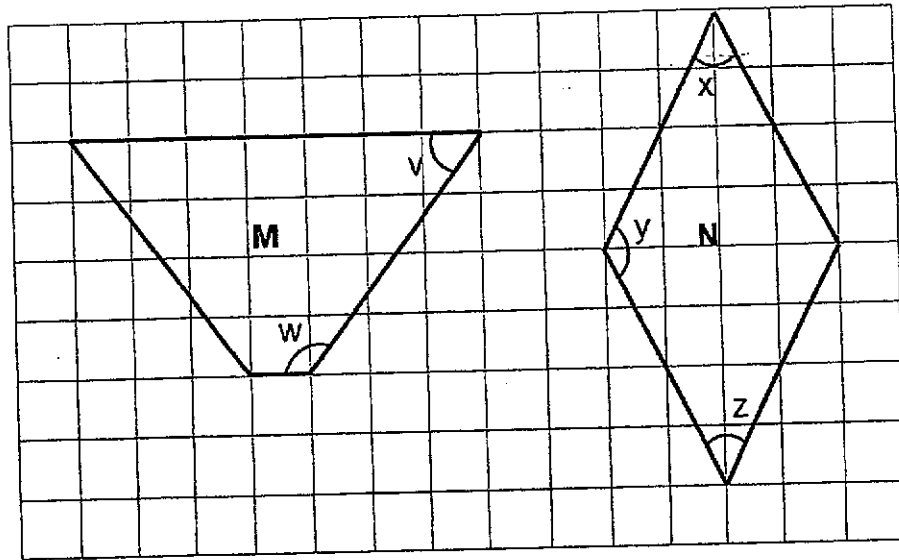

Which of the statement(s) is/are true?

- A. $\angle w + \angle x + \angle y + \angle z = 360^\circ$
 - B. Figure M has the same perimeter as Figure N
 - C. Figure M has the same area as Figure N
- (1) C only
- (2) A and B only
- (3) A and C only
- (4) B and C only

15. The table shows how a group of 110 students go to school.

Mode	Walk	Bus	Car	Train
Students	30	40	15	25

Which of the following bar graphs represents the information shown in the table above?

(1)

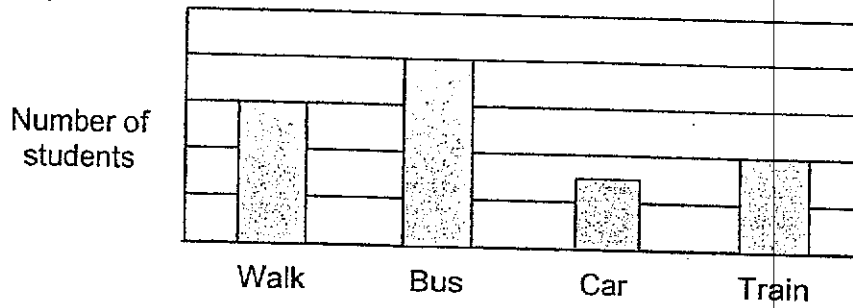

(2)

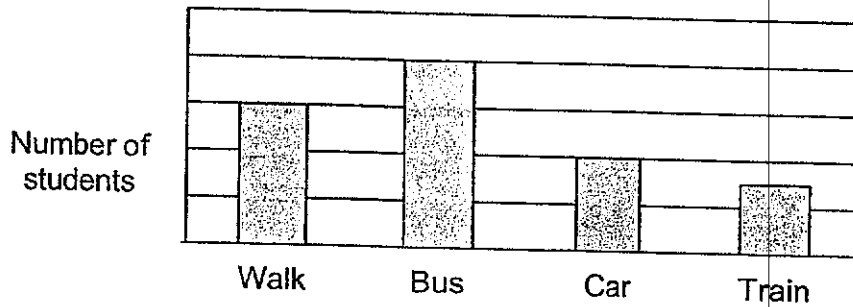

(3)

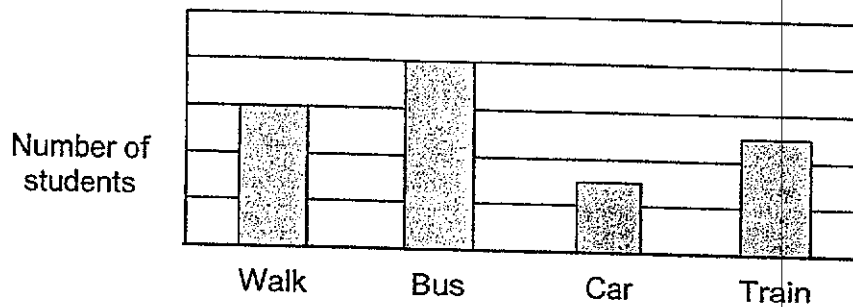

(4)

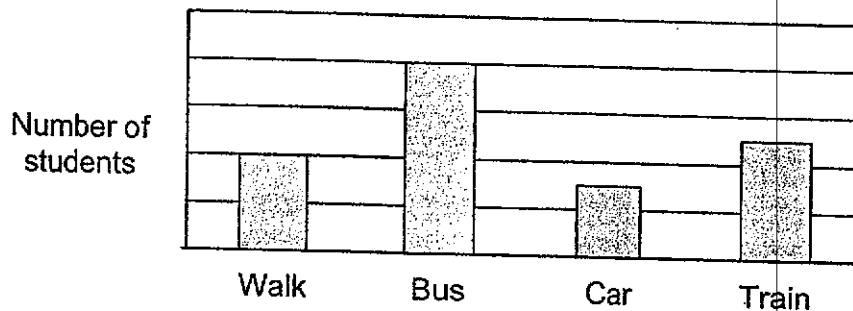

- End of Booklet A -



PEI HWA PRESBYTERIAN PRIMARY SCHOOL
PRELIMINARY EXAMINATION

PRIMARY 6
MATHEMATICS PAPER 1
(BOOKLET B)

19 August 2021

Parent's signature

Name: _____

Form Class / Register No. : 6R _____ / _____

Total time for Booklets A and B: 1h

INSTRUCTIONS TO CANDIDATES

1. Write your Name, Class and Register No. in the spaces provided above.
2. DO NOT turn over this page until you are told to do so.
3. Follow all instructions carefully.
4. Answer all questions.
5. Write all your answers in this booklet.
6. The use of calculator is **NOT ALLOWED**.

Marks (Booklet A) :	20
Marks (Booklet B) :	25
Total Marks (Booklets A and B) :	45

This booklet consists 7 printed pages, excluding the cover page.

Questions 16 to 20 carry 1 mark each. Write your answers in the spaces provided. For questions which require units, give your answers in the units stated. (5 marks)

Do not write in this space

16. Find the value of $\frac{3}{4} \div \frac{9}{10}$

Ans: _____

17. Express $\frac{5}{8}$ as a percentage.

Ans: _____%

18. A bag of rice is placed on a scale. The figure shows part of a scale. What is the mass of the bag of rice?

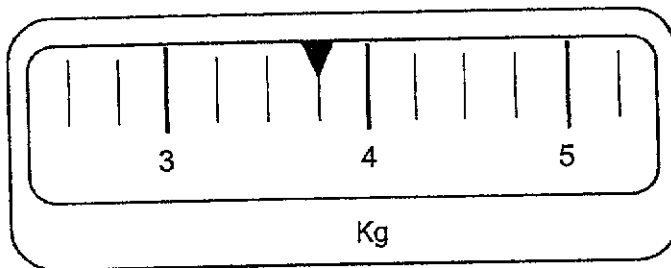

Ans: _____ kg

19. How many marked angles in the figure below are greater than a right angle?

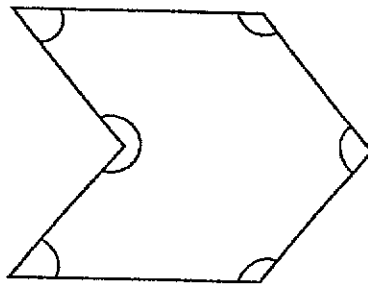

Do not write
in this space

Ans: _____

20. The line graph shows the number of bicycles rental from February to June. In which one-month interval period was the increase in the number of bicycles rental the most?

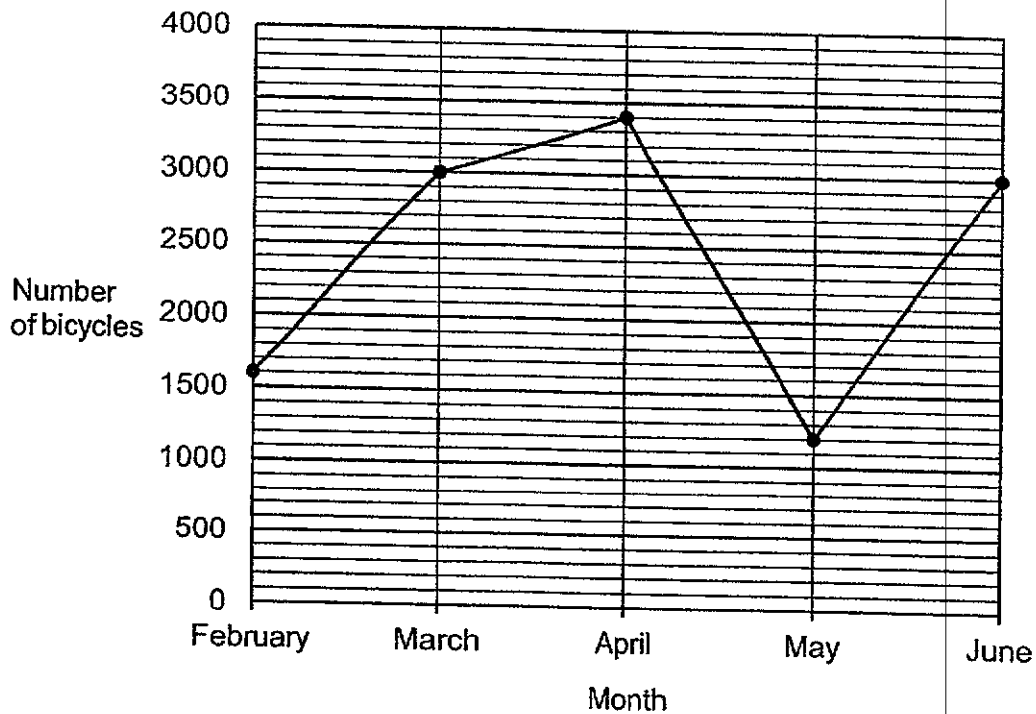

Ans: From _____ to _____

Questions 21 to 30 carry 2 marks each. Show your working clearly and write your answers in the spaces provided. For questions which require units, give your answers in the units stated. (20 marks)

Do not write in this space

21. 10.4 kg of flour was packed equally into 20 bags.
How much flour was in each bag?

Ans: _____ kg

22. A machine prints 60 pages in 10 minutes.
At the same rate, how many pages can it print in 2 hours?

Ans: _____

23. Find the value of $4t - \frac{5t}{3} + 8$ when $t = 6$.

Ans: _____

24. Siti had 1 ℓ of syrup. She used $\frac{1}{5}$ ℓ of syrup on Saturday and $\frac{5}{6}$ of the remaining syrup on Sunday. How many litres of syrup did Siti have left?
Leave your answer in the simplest form.

Ans: _____ ℓ

25. Mr Poh worked 3 h 45 min in the morning and 4 h 30 min in the afternoon.

- (a) How long did he work in total for the day?
- (b) Mr Poh had an hour of lunch in between work. He left work at 17 25. At what time did he start working? Give your answer in 24 hour clock.

Do not write
in this space

Ans: (a) _____ h _____ min

(b) _____

26. The square grid shows the position of points A, B, C, D, E, F, G, H and I.

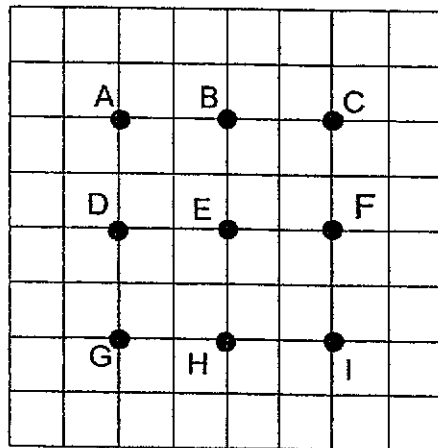

- (a) In which direction is G from C?
- (b) Mandy stood at one of the points facing A. After she turned 135° clockwise, she faced F. Which point was Mandy at?

Ans: (a) _____

(b) _____

Do not write
in this space

27. Bala bent an 80 cm wire to form a figure of 2 squares X and Y as shown below.
The area of square X is $\frac{1}{4}$ the area of square Y. What is the area of square X?

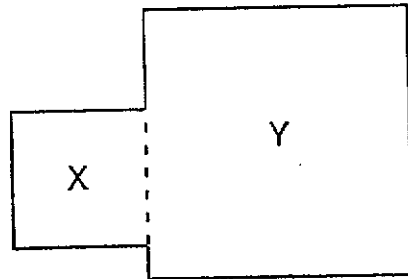

Ans: _____ cm²

28. Adam, Bryan and Charlie each had some money. Bryan and Charlie had a total of \$5.90 more than Adam. Adam and Charlie had a total of \$20.70 more than Bryan. How much more money did Adam have than Bryan?

Ans: \$ _____

29. The bar graph shows the total number of hours worked by 3 companies from January to March.

Do not write in this space

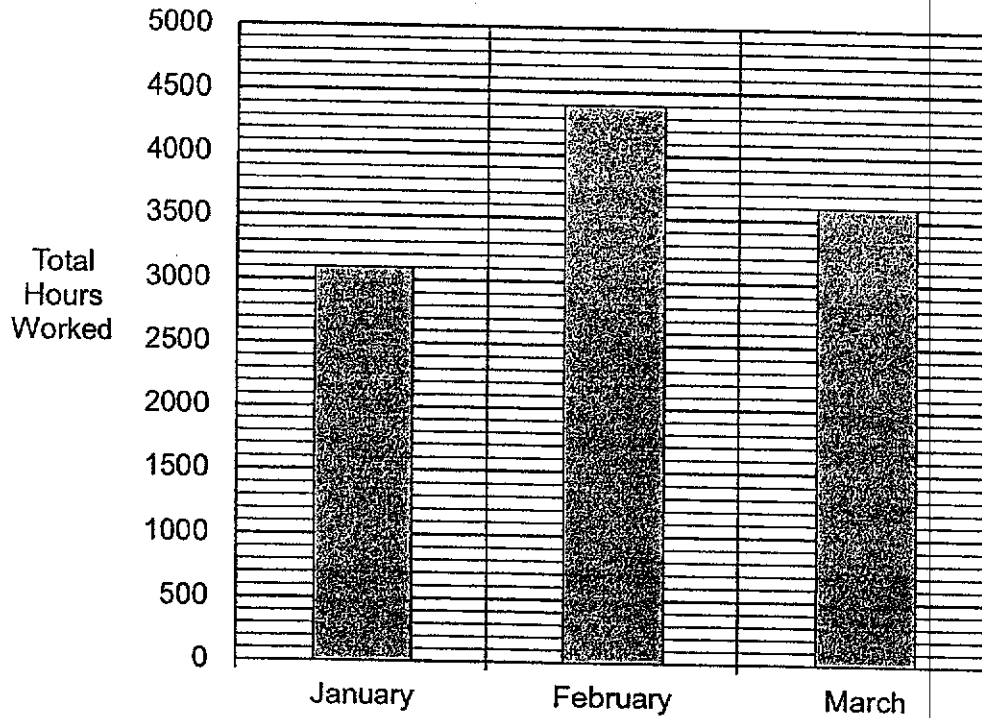

The bar graph shows the number of workers in each company from January to March.

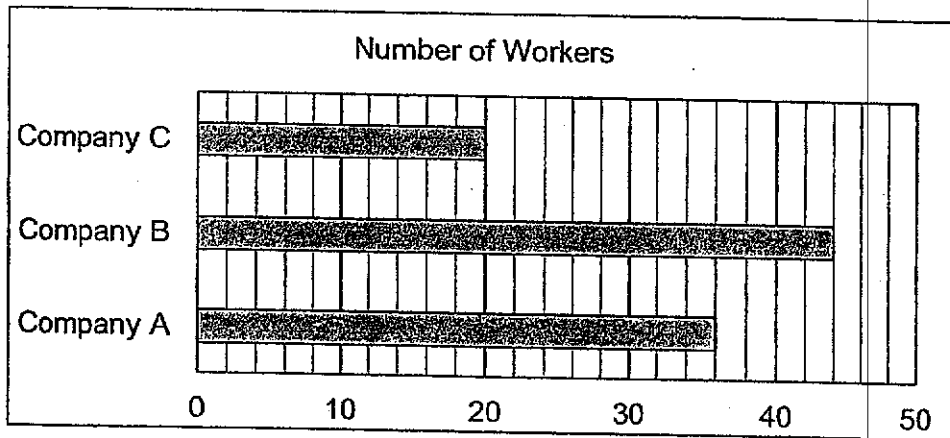

What was the average number of hours worked by each worker from January to March?

Ans: _____ h

Do not write in this space

30. The figure below shows a trapezium VWXY. VZY is a straight line.

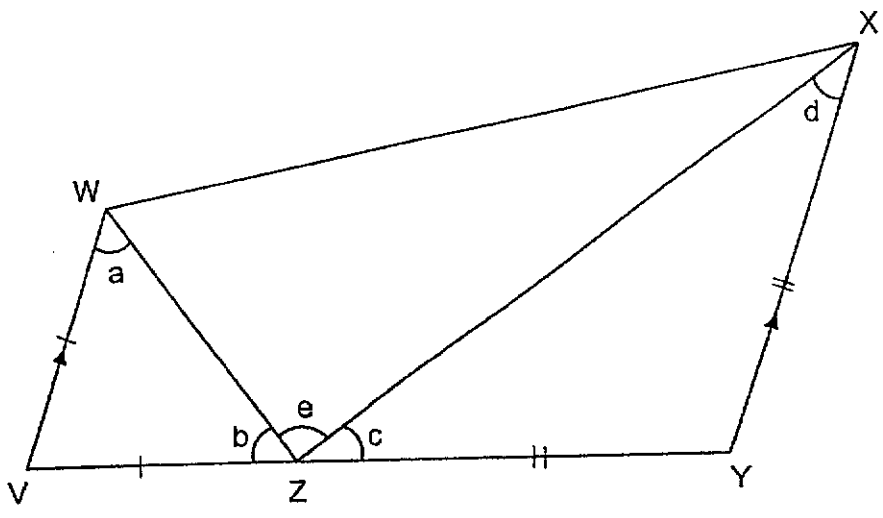

Each of the statements below is either true, false or not possible to tell from the information given. For each statement, put a tick (✓) to indicate your answer.

Statement	True	False	Not possible to tell
$\angle a + \angle b + \angle c + \angle d = 180^\circ$			
$\angle b + \angle c = 90^\circ$			
WXYZ is a trapezium			

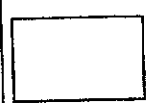

End of Paper



PEI HWA PRESBYTERIAN PRIMARY SCHOOL
PRELIMINARY EXAMINATION

PRIMARY 6
MATHEMATICS
PAPER 2

19 August 2021

Parent's signature

Name: _____

Form Class / Register No. : 6R _____ / _____

Total time: 1h 30min

INSTRUCTIONS TO CANDIDATES

1. Write your Name, Class and Register No. in the spaces provided above.
2. DO NOT turn over this page until you are told to do so.
3. Follow all instructions carefully.
4. Answer all questions.
5. Write all your answers in this booklet.
6. The use of an approved calculator is expected, where appropriate.

Booklet A :		Booklet B :		Total:	45
				Paper 2 :	55
				Total Marks :	100

This booklet consists of 19 printed pages, excluding the cover page.

Questions 1 to 5 carry 2 marks each. Show your working clearly and write your answers in the spaces provided. For questions which require units, give your answers in the units stated. (10 marks)

Do not write in this space

1. The figure below shows a rectangular tank containing some water. How much water has to be poured out of the tank for it to be $\frac{2}{5}$ full?

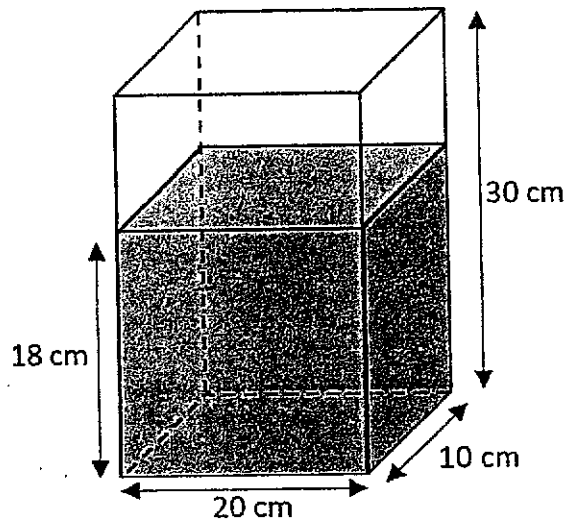

Ans: _____ ml

Do not write
in this space

2. Henry's monthly salary was \$500.
The line graph shows the amount of money he spent each month.

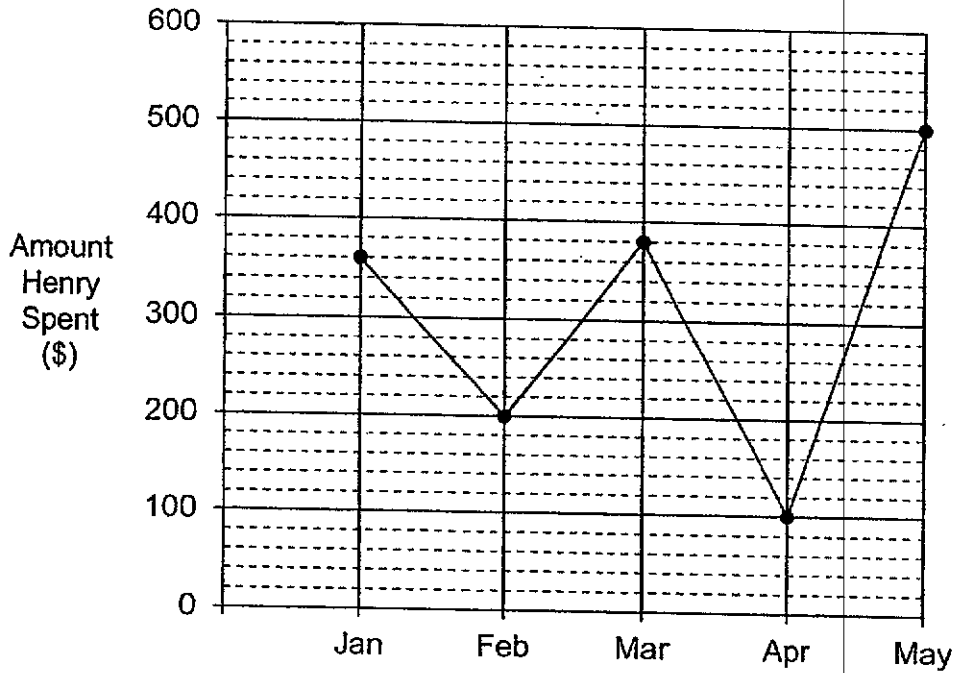

Write down all the months in which Henry spent more than $\frac{3}{4}$ of his monthly salary.

Ans: _____

Do not write
in this space

3. A rectangle has a perimeter of $(y + 9)$ cm. The breadth is 2 cm.
- (a) What is the length of the rectangle in term of y ?
- (b) Find the area of the rectangle if y is 11 cm.

Ans (a) : _____ cm

(b) : _____ cm²

- 4 In a bag, $\frac{3}{8}$ of the buttons were green. There were four times as many blue as red buttons. There were 24 more blue than green buttons. What was the total number of buttons in the bag?

Ans: _____

5. Measure and write down

Do not write
in this
space

(a) the size of $\angle WXY$

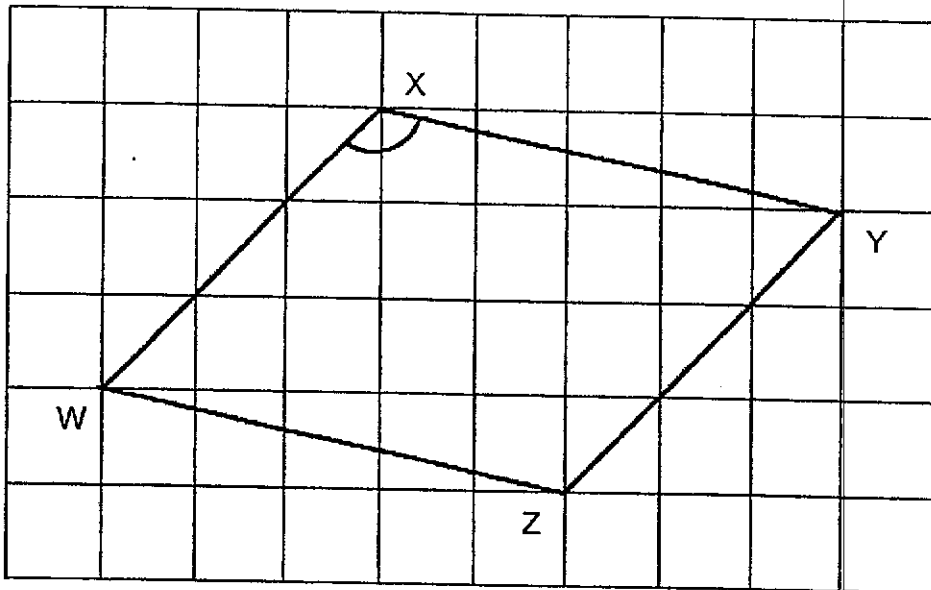

Ans: (a) _____^o

(b) Circle the words that describe WXYZ correctly in the following statement:

WXYZ is a (parallelogram / rhombus) because all four sides (are / are not) equal in length.



For questions 6 to 17, show your working clearly and write your answers in the spaces provided. The number of marks available is shown in brackets [] at the end of each question or part-question. (45 marks)

Do not write in this space

6. (a) Draw the rectangular block on the grid provided. ST has been drawn for you.

[1]

- (b) Ali painted the whole rectangular block with red paint. He then cut the block into smaller unit cubes. What is the greatest number of unit cubes he can get?
- (c) How many of the unit cubes had exactly two of their faces painted red?

Ans: (b) _____ [1]

(c) _____ [1]



Do not write in this space

7. The table shows the mailing charges to Korea.

Mass Step	By Sea	By Air
First 100 g	\$0.40	\$1.80
For every additional 100 g	\$1.20	\$8.40

- (a) Kelly sent a parcel weighing 250 g to Korea by sea. How much did she pay for the mailing charges?
- (b) Mary paid a total of \$29.20 to send a parcel to Korea. By which way did she send the parcel? What was the greatest possible mass of the parcel in kilograms?

Ans: (a) _____ [1]

(b) Way: _____ ;

_____ [2]

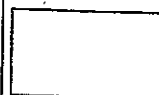

8. A triangle R is drawn on the square grid as shown below.

(a) Find the area of triangle R.

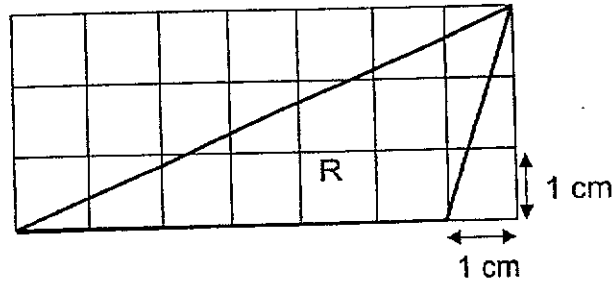

(b) Within the square grid below, draw and label a right-angled triangle ABC such that triangle ABC is three times the area of triangle R. Line AB has been drawn. [1]

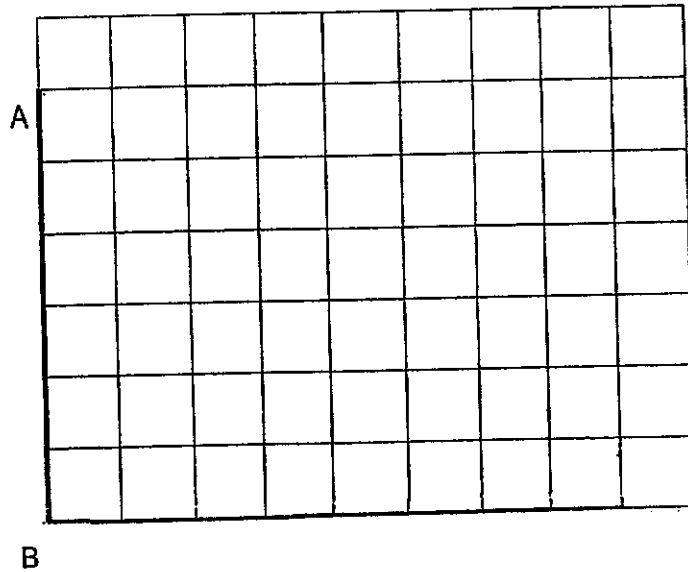

(c) Measure the line AC to the nearest centimetre.

Ans (a): _____ [1]

(c): _____ [1]



9. There are 8 boys and 14 girls. An equal number of sweets were given to each child. When the girls gave $\frac{2}{3}$ of their sweets to the boys, the boys had 264 more sweets than the girls. How many sweets did the girls give to the boys?

Ans: _____ [3]

Do not write
in this space

10. The line graph shows the amount of water that flows from Tap A into an empty tank over 25 minutes.

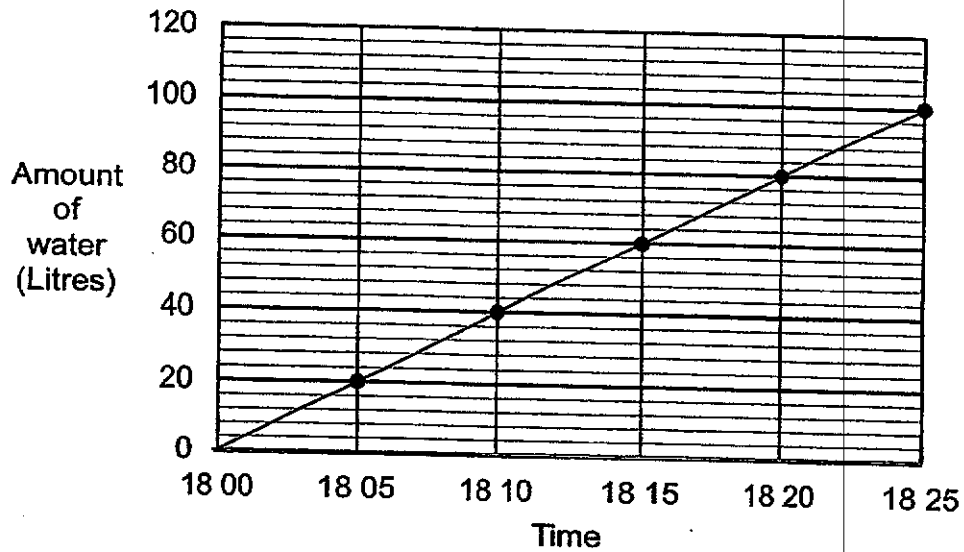

Tap B was turned on at 18 05 to drain water out of the same tank. Both taps were then turned off at 18 25.

The line graph shows the volume of water left in the tank from the start.

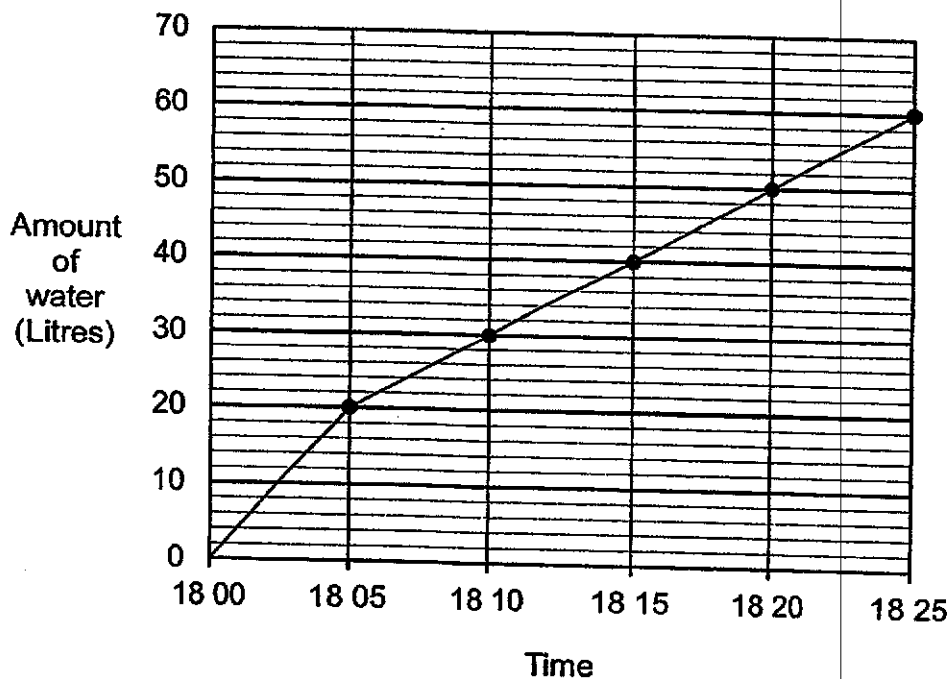

- (a) What was the amount of water in the tank when Tap B was turned on at 18 05?
- (b) What was the amount of water left in the tank at 18 15?
- (c) How many litres of water was drained out in a minute?

Ans: (a) _____ [1]

(b) _____ [1]

(c) _____ [1]

11. In the pattern below, each square is either empty or filled with a circle.

Do not write in this space



Fig 1

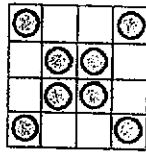

Fig 2

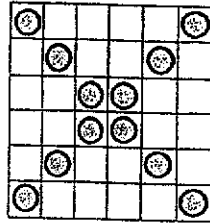

Fig 3

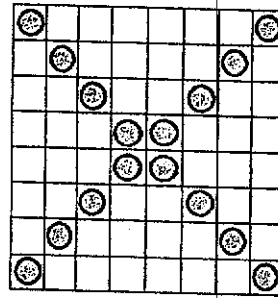

Fig 4

- (a) How many circles are there in Figure 10?
 (b) Which figure has 624 empty squares?

Ans: (a) _____ [1]

(b) _____ [2]



Do not write
in this space

12. Jack had 3 times as much money as Bill at first. Bill received some money and Jack spent some money. The amount Bill received was 4 times the amount Jack spent. After that, both of them had the same amount of money. They had a total of \$332.80 in the end.

- (a) What fraction of his money did Jack spend?
- (b) How much money did Bill receive?

Ans: (a) _____ [2]

(b) _____ [2]

Do not write
in this space

13. In the figure below, rectangle ABCD overlaps with a circle with centre A. The area of the shaded part is $\frac{1}{3}$ the area of the rectangle. The total area of the unshaded parts of the figure is 770 cm^2 . Take $\pi = \frac{22}{7}$

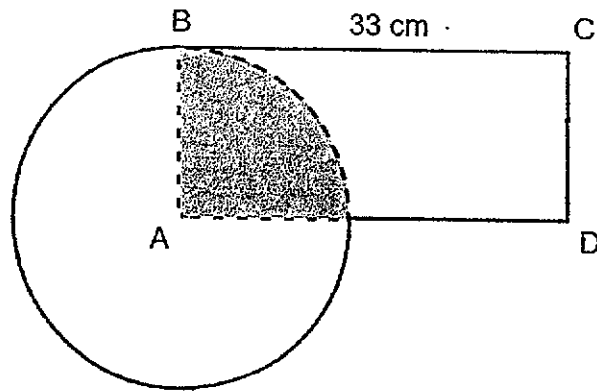

- (a) Find the length of AB.
(b) What is the perimeter of the figure?

Ans: (a) _____ [3]

(b) _____ [2]



Do not write
in this space

14. In the figure, ABCD is made up of triangles ABC, ACE and AED. $AD = EB$.
CED is a straight line.

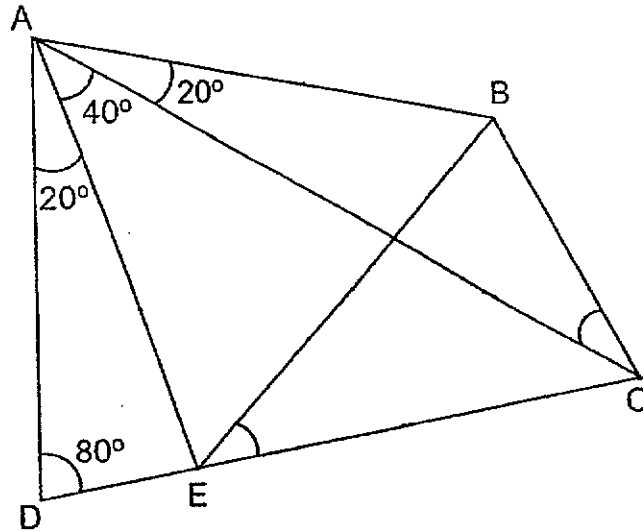

- (a) Find $\angle BEC$.
(b) Find $\angle ACB$.

Ans: (a) _____ [2]

(b) _____ [2]

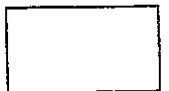

Do not write
in this space

15. Dani collected \$235 in a donation drive on Saturday. The number of \$2, \$5 and \$10 notes were in the ratio of 6 : 3 : 2. Dani collected another \$68 on Sunday. As a result, the number of \$2 notes was increased by 30% and the number of \$5 notes was increased by 40%. The remaining notes were \$10.

- (a) How many \$10 notes were collected on Saturday?
- (b) What was the percentage increase in the number of \$10 notes collected from Saturday to Sunday?

Ans: (a) _____ [2]

(b) _____ [3]

16. The figure is made up of two squares. ABC is a straight line.

- (a) Find $\angle x$
- (b) Find $\angle y$

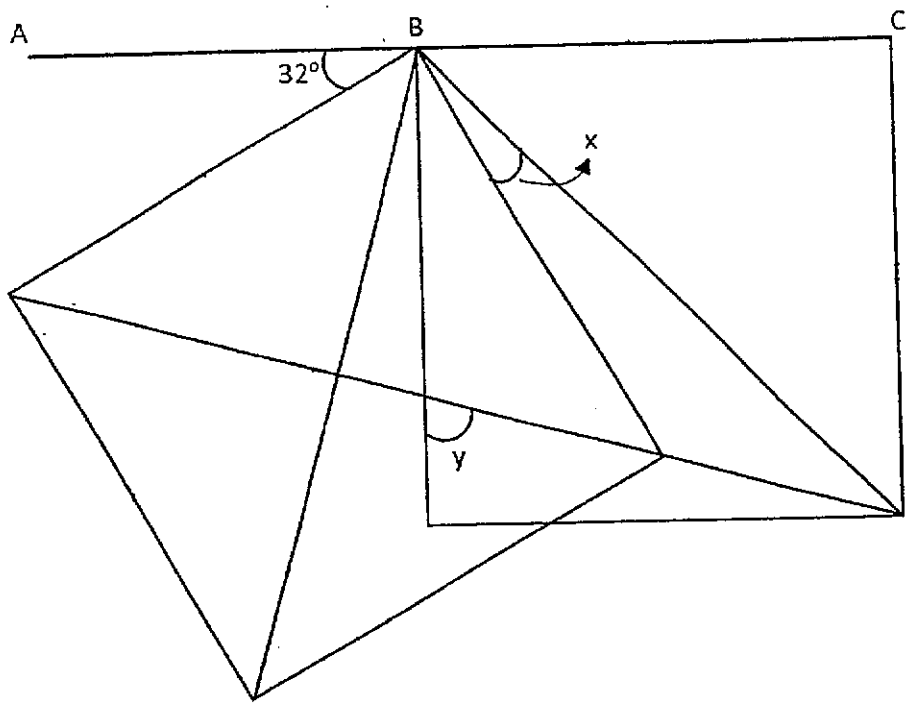

Ans: (a) _____ [2]

(b) _____ [2]

Do not write
in this space

17. In a donation drive, five classes A, B, C, D and E baked some cupcakes for sale. The bar graph shows the number of cupcakes baked by classes A, B, C and D. The number of cupcakes baked is not shown on the scale. The bar for the number of cupcakes baked by class E has not been drawn.

Number of Cupcakes Baked By Each Class

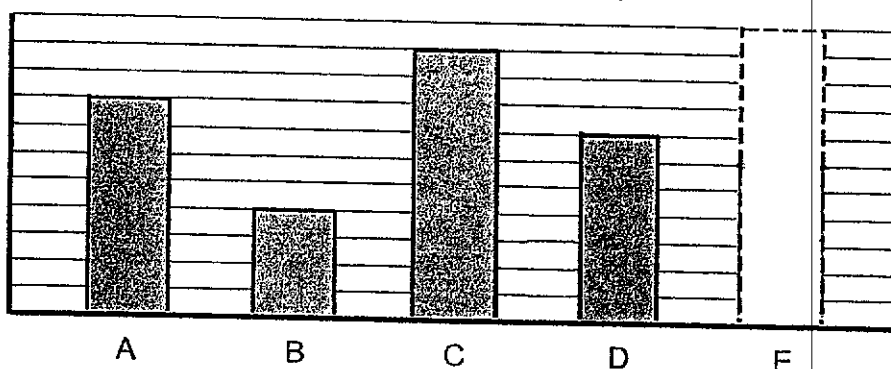

- (a) The average number of cupcakes baked by the five classes is the same as the number of cupcakes baked by class D. How many cupcakes did class E bake? Draw your answer on the bar graph. [2]
- (b) The table shows the number of cupcakes sold by classes A, B, C and D.

Classes	Number of Cupcakes Sold	
	Small	Large
A	44	20
B	8	24
C	48	32
D	22	34
E		

Classes D and E sold 80% of their baked cupcakes.
How many cupcakes did class D bake?

- (c) Write down one possible set of values for the number of small and large cupcakes sold by class E.

Please show your working and answers on the next page.

Ans: (b) _____ [1]

(c) Small: _____

Large: _____ [2]

-- End of Paper 2 --

SCHOOL : PEIHWA PRESBYTERIAN PRIMARY SCHOOL
 LEVEL : PRIMARY 6
 SUBJECT : MATH
 TERM : 2021 SA2

PAPER 1 BOOKLET A

Q 1	Q2	Q3	Q4	Q5	Q6	Q7	Q8	Q9	Q10
3	3	2	3	2	1	1	2	4	2

Q 11	Q12	Q13	Q14	Q15
3	2	4	3	3

PAPER 1 BOOKLET B

Q16)	5 6
Q17) 62.5	
Q18) 3.75	
Q19) 4	
Q20) May to June	
Q21) 0.52kg	
Q22) 720	
Q23) $6 \times 4 = 24$ $5 \times 6 = 30$ $24 - 30/3 + 8 = 22$	
Q24) $2/15$	
Q25) a) 8h 15min b) 0810	
Q26) a) South west b) E	
Q27) 64cm^2	
Q28) \$7.40	
Q29) 111h	
Q30) True True False	

PAPER 2

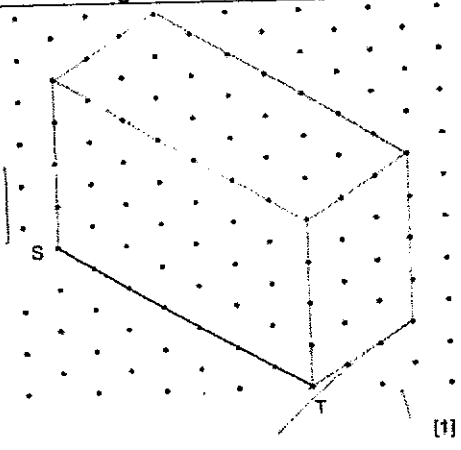
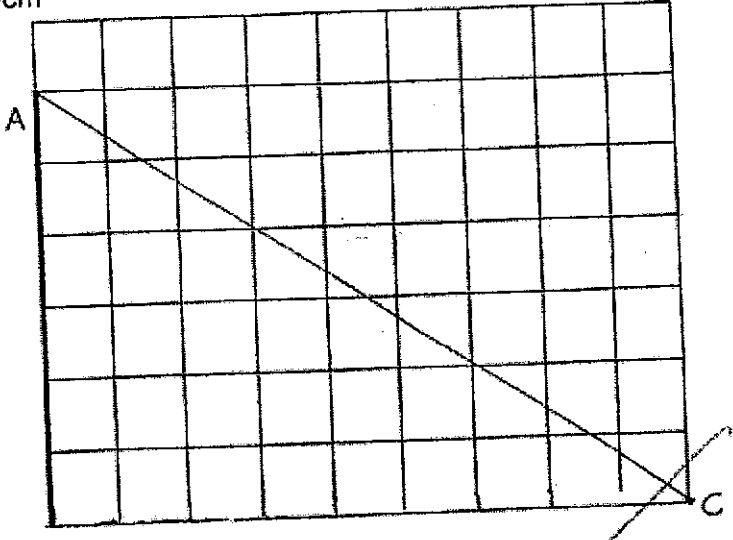
Q1)	$20 \times 10 \times 30 \times \frac{2}{5} = 2400$ $20 \times 10 \times 18 = 3600$ $3600 - 2400 = 1200$
Q2)	March and may
Q3)	a) $\frac{y+5}{2}$ b) 16
Q4)	192
Q5)	a) 123 b) Parallelogram > are not
Q6)	 a) } b) 84 c) 32
Q7)	a) $0.4 + 1.20 + 1.20 = 280$ $= \$2.80$ b) Sea ; 2.5kg
Q8)	a) 9cm^2  b) B c) 11cm
Q9)	308

Q10)	a) 20 l b) 40 l c) 2 l
Q11)	a) 40 b) 13
Q12)	a) $\frac{2}{15}$ b) \$102.40
Q13)	$5u = 770$ $1u = 154$ $3u = 462$ $462 \div 33 = 14$ $14 \times 2 = 28$ $33 - 14 = 19$ a) 14cm b) 132cm
Q14)	a) 40° b) 30°
Q15)	a) 10 b) 20%
Q16)	a) $180 - 32 = 148$ $1 + 8 - 90 - 90 = -32$ $45 - 32 = 13$ $180 - 90 - 13 = 77$ 13° b) 77°
Q17)	<p style="text-align: center;">Number of Cupcakes Baked By Each Class</p> <p>a) 70 b) 70 c) Small 39 Large 9</p>